

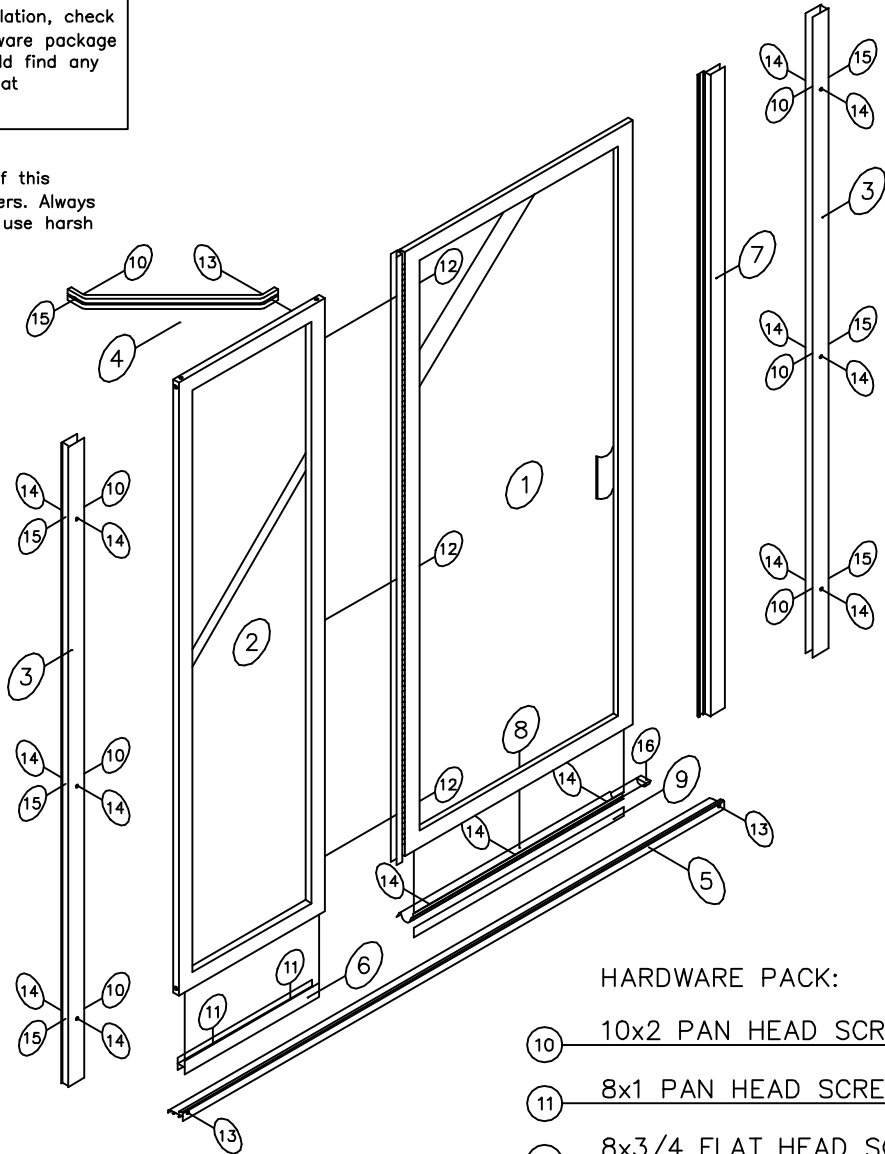











**\* PLEASE NOTE:** Before beginning installation, check that parts contained in the carton and hardware package match those parts listed below. If you should find any discrepancies please contact Holcam Sales at 800-843-3332

**WARNING:** To avoid damaging the finish of this deluxe shower enclosure, use only mild cleaners. Always read the labels on the cleaner used. Do not use harsh chemicals or abrasive detergents.



	CAT#:	PART LIST:	LENGTH:	QTY:
	1	H-22 DOOR ASSEMBLY	63 1/2"	1
	2	PANEL ASSEMBLY		1
	3	H-31 WALL JAMB	62 3/4"	2
	4	H-16 ANGLE BRACE		1
	5	H-25 THRESHOLD		1
	6	H-35 PANEL FILLER		1
	7	H-17 STRIKE JAMB	62 3/4"	1
	8	H-11 GUTTER		1
	9	V-8 GUTTER VINYL		1

HARDWARE PACK: QTY:

	10x2 PAN HEAD SCREW	7
	8x1 PAN HEAD SCREW	2
	8x3/4 FLAT HEAD SCREW	3
	6x3/4 PAN HEAD SCREW	3
	6x3/8 PAN HEAD SCREW	15
	PLASTIC ANCHOR	7
	GUTTER PLUG	1

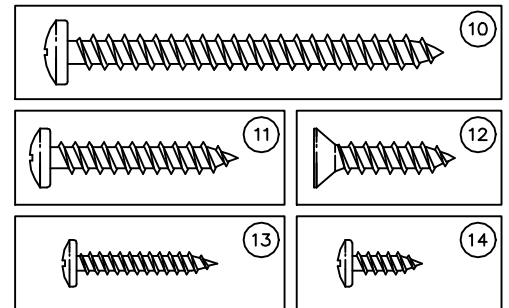

**MODEL A-10  
MAGNETIC STRIKE  
HINGE  
OFF PANEL**

**TOOLS REQUIRED FOR INSTALLATION OF MODEL A-10 WITH HINGE OFF PANEL:**

1. Caulking gun + approved silicone sealant
2. Rubber mallet
3. Hacksaw
4. Philips screwdriver
5. Mill file to smooth cut edges or radius
6. 1/8" drill bit for 6x screws
7. 9/64" drill bit for 8x screws
8. 5/32" drill bit for 10x2 screws
9. 1/4" drill bit for plastic anchors
10. 1/4" carbide drill bit for tile anchors

**1** Measure finished opening width at bottom of stall. Cut threshold to this dimension. Radius ends if stall has rounded corners (fiberglass).

**2** Place wall jambs on threshold and plumb. Mark hole locations and drill 1/4" holes for plastic anchors. Secure jambs to wall with 10x2 screws.

**3** Trim top extension of door hinge jamb to flush with door top. Attach hinge jamb of door onto panel and fasten with 8x3/4 flat head screws so that top of panel is flush with top of door.

**4** Place strike jamb into wall jamb. Slide door and panel assembly into the other wall jamb, then adjust and plumb for 1/8" clear gap between door and strike jamb.

**5** Measure distance between wall jamb and hinge jamb under the panel. Cut filler to length, then drill and install with 8x1 screws. Replace door panel assembly.

**6** Push or pull on panel in wall jamb to adjust fit of strike jamb to door. Level angle brace and secure with 10x2 screw into plastic anchor in wall, and with one 6x3/4 screw to attach angle brace to panel rail.

**7** Secure strike jamb to wall jamb and panel assembly to wall jamb with three 6x3/8 screws inside and three 6x3/8 screws outside on each wall jamb. (Twelve total).

**8** Locate and drill holes through threshold at wall jambs as illustrated. Secure threshold to wall jambs with one 6x3/4 screw at each end.

**9** Install gutter over gutter vinyl at door bottom with 6x3/8 screws. Be sure gutter slopes down to hinge end, and vinyl extends to within 1/8" of threshold.

**10** NOTE: We recommend filing any sharp corners that may cause injury, then clean and run a continuous bead of sealant along the outside of the threshold and up the wall jambs. Do NOT caulk inside of the unit.

NOTE: Polarity of the magnet in the strike jamb may be reversed. To change polarity, remove magnetic strip from strike jamb, turn end for end, and re-install.